

EME720

Wind-Driven Rain Resistant Stationary Louver Extruded Aluminum



APPLICATION

The EME720 is a 7" deep horizontal louver that combines a continuous-blade architectural appearance with the performance of a wind-driven rain-resistant louver. It appeals to architects looking for a long, uninterrupted look that will enhance a variety of monumental structures, including stadiums, arenas and convention centers.

STANDARD CONSTRUCTION

Frame	7" (178) deep, 6063T6 extruded aluminum with .080" (2.0) nominal wall thickness.
Blades	6063T6 extruded aluminum .075" (1.9) nominal wall thickness with sightproof blades.
Screen	5/8" x .040" (16 x 1) expanded flattened aluminum bird screen in removable frame. Screen adds approximately 1/2" (13) to louver depth.
Finish	Mill.
Minimum Size	12"w x 12"h (305 x 305).
Approximate Shipping Weight	8 lbs. per sq. ft. (39 kg/m ²).
Maximum Factory Assembly Size	Single sections shall not exceed 120"w x 90"h (3048 x 2286) or 90"w x 120"h (2286 x 3048). Louvers larger than the maximum single section size will require field assembly of smaller sections.
Supports	Louvers may be provided with rear mounted blade supports that increase overall louver depth depending on louver size, assembly configuration or windload.

Consult Ruskin for additional information.

FEATURES

- ▶ Closely spaced horizontal blades minimize the penetration of winddriven rain, reducing damage and additional operating expenses. Optional 4" depth with or without blankoff for inactive louver areas.
- ▶ Tested in accordance with the AMCA 500-L Wind-Driven Rain Penetration Test.
- ▶ Published performance ratings based on testing in accordance with AMCA Publication 511.
- ▶ Performance Ratings:
55% Free Area.
Beginning Point of Water Penetration 1105 FPM (337 m/min.).
Pressure Loss @ 1105 FPM is approximately .40 in w.g. (100 Pa) (Intake).
- ▶ Aluminum construction for low maintenance and high resistance to corrosion.

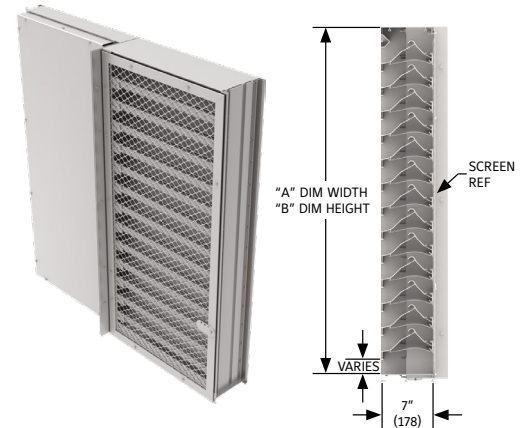

OPTIONS

- ▶ Extended sill.
- ▶ Hinged frame.
- ▶ Front or rear security bars.
- ▶ Filter racks.
- ▶ Front Flange.
- ▶ Sleeve.
- ▶ Blankoff Panel.
- ▶ Installation angles.
- ▶ A variety of bird and insect screens.
- ▶ Optional finishes available at additional cost : Prime coat, 50% PVDF (modified fluoropolymer), Epoxy, Pearledize 50 and 70, 70% PVDF, Clear and Color Anodized finishes.(Some variation in anodize color consistency is possible).

Consult Ruskin for other special requirements.

NOTE:

1. Dimensions in inches, parenthesis () indicate millimeters.
2. Units furnished 1/4" (6) smaller than given opening dimensions.

FREE AREA GUIDE

Free Area Guide shows free area in ft² and m² for various sizes of EME720.

Width – Inches and Meters

	12	18	24	30	36	42	48	54	60	66	72	78	84	90	96	102	108	114	120
	0.30	0.45	0.60	0.75	0.90	1.05	1.20	1.35	1.50	1.65	1.80	1.95	2.10	2.25	2.40	2.55	2.70	2.85	3.00
12	0.32	0.52	0.72	0.91	1.11	1.31	1.50	1.70	1.90	2.09	2.29	2.48	2.68	2.88	3.07	3.27	3.47	3.66	3.86
0.30	0.03	0.05	0.07	0.08	0.10	0.12	0.14	0.16	0.18	0.19	0.21	0.23	0.25	0.27	0.29	0.30	0.32	0.34	0.36
18	0.59	0.95	1.32	1.68	2.04	2.40	2.76	3.12	3.48	3.84	4.20	4.56	4.92	5.28	5.64	6.01	6.37	6.73	7.09
0.45	0.06	0.09	0.12	0.16	0.19	0.22	0.26	0.29	0.32	0.36	0.39	0.42	0.46	0.49	0.52	0.56	0.59	0.63	0.66
24	0.86	1.39	1.91	2.44	2.96	3.49	4.01	4.54	5.06	5.59	6.11	6.64	7.16	7.69	8.21	8.74	9.26	9.79	10.31
0.60	0.08	0.13	0.18	0.23	0.28	0.32	0.37	0.42	0.47	0.52	0.57	0.62	0.67	0.72	0.76	0.81	0.86	0.91	0.96
30	1.13	1.82	2.51	3.20	3.89	4.58	5.27	5.96	6.65	7.34	8.03	8.72	9.41	10.10	10.78	11.47	12.16	12.85	13.54
0.75	0.11	0.17	0.23	0.30	0.36	0.43	0.49	0.55	0.62	0.68	0.75	0.81	0.87	0.94	1.00	1.07	1.13	1.20	1.26
36	1.37	2.21	3.05	3.88	4.72	5.55	6.39	7.22	8.06	8.89	9.73	10.56	11.40	12.23	13.07	13.90	14.74	15.58	16.41
0.90	0.13	0.21	0.28	0.36	0.44	0.52	0.59	0.67	0.75	0.83	0.90	0.98	1.06	1.14	1.22	1.29	1.37	1.45	1.53
42	1.65	2.64	3.64	4.64	5.64	6.64	7.64	8.64	9.64	10.64	11.64	12.64	13.64	14.64	15.64	16.64	17.64	18.64	19.64
1.05	0.15	0.25	0.34	0.43	0.52	0.62	0.71	0.80	0.90	0.99	1.08	1.18	1.27	1.36	1.45	1.55	1.64	1.73	1.83
48	1.92	3.08	4.24	5.41	6.57	7.73	8.90	10.06	11.23	12.39	13.55	14.72	15.88	17.05	18.21	19.37	20.54	21.70	22.87
1.20	0.18	0.29	0.39	0.50	0.61	0.72	0.83	0.94	1.04	1.15	1.26	1.37	1.48	1.59	1.69	1.80	1.91	2.02	2.13
54	2.19	3.51	4.84	6.17	7.50	8.83	10.15	11.48	12.81	14.14	15.47	16.80	18.12	19.45	20.78	22.11	23.44	24.76	26.09
1.35	0.20	0.33	0.45	0.57	0.70	0.82	0.94	1.07	1.19	1.31	1.44	1.56	1.69	1.81	1.93	2.06	2.18	2.30	2.43
60	2.46	3.95	5.44	6.93	8.43	9.92	11.41	12.90	14.40	15.89	17.38	18.87	20.37	21.86	23.35	24.84	26.34	27.83	29.32
1.50	0.23	0.37	0.51	0.64	0.78	0.92	1.06	1.20	1.34	1.48	1.62	1.76	1.89	2.03	2.17	2.31	2.45	2.59	2.73
66	2.73	4.38	6.04	7.70	9.35	11.01	12.67	14.32	15.98	17.64	19.29	20.95	22.61	24.26	25.92	27.58	29.23	30.89	32.55
1.65	0.25	0.41	0.56	0.72	0.87	1.02	1.18	1.33	1.49	1.64	1.79	1.95	2.10	2.26	2.41	2.56	2.72	2.87	3.03
72	3.00	4.82	6.64	8.46	10.28	12.10	13.92	15.74	17.56	19.39	21.21	23.03	24.85	26.67	28.49	30.31	32.13	33.95	35.77
1.80	0.28	0.45	0.62	0.79	0.96	1.13	1.29	1.46	1.63	1.80	1.97	2.14	2.31	2.48	2.65	2.82	2.99	3.16	3.33
78	3.24	5.20	7.17	9.14	11.11	13.07	15.04	17.01	18.97	20.94	22.91	24.87	26.84	28.81	30.78	32.74	34.71	36.68	38.64
1.95	0.30	0.48	0.67	0.85	1.03	1.22	1.40	1.58	1.76	1.95	2.13	2.31	2.50	2.68	2.86	3.05	3.23	3.41	3.59
84	3.51	5.64	7.77	9.90	12.03	14.16	16.30	18.43	20.56	22.69	24.82	26.95	28.08	31.21	33.35	35.48	37.61	39.74	41.87
2.10	0.33	0.52	0.72	0.92	1.12	1.32	1.52	1.71	1.91	2.11	2.31	2.51	2.70	2.90	3.10	3.30	3.50	3.70	3.89
90	3.78	6.07	8.37	10.66	12.96	15.26	17.55	19.85	22.14	24.44	26.73	29.03	31.32	33.62	35.92	38.21	40.51	42.80	45.10
2.25	0.35	0.56	0.78	0.99	1.21	1.42	1.63	1.85	2.06	2.27	2.49	2.70	2.91	3.13	3.34	3.55	3.77	3.98	4.19
96	4.05	6.51	8.97	11.43	13.89	16.35	18.81	21.27	23.73	26.19	28.65	31.11	33.57	36.03					
2.40	0.38	0.61	0.83	1.06	1.29	1.52	1.75	1.98	2.21	2.44	2.66	2.89	3.12	3.35					
102	4.32	6.94	9.57	12.19	14.82	17.44	20.06	22.69	25.31	27.94	30.56	33.18	35.81	38.43					
2.55	0.40	0.65	0.89	1.13	1.38	1.62	1.87	2.11	2.35	2.60	2.84	3.09	3.33	3.57					
108	4.59	7.38	10.17	12.95	15.74	18.53	21.32	24.11	26.90	29.68	32.47	35.26	38.05	40.84					
2.70	0.43	0.69	0.95	1.20	1.46	1.72	1.98	2.24	2.50	2.76	3.02	3.28	3.54	3.80					
114	4.83	7.76	10.70	13.63	16.57	19.50	22.44	25.37	28.30	31.24	34.17	37.11	40.04	42.98					
2.85	0.45	0.72	0.99	1.27	1.54	1.81	2.09	2.36	2.63	2.91	3.18	3.45	3.72	4.00					
120	5.10	8.20	11.30	14.40	17.49	20.59	23.69	26.79	29.89	32.99	35.09	39.19	42.28	45.38					
3.00	0.47	0.76	1.05	1.34	1.63	1.92	2.20	2.49	2.78	3.07	3.36	3.64	3.93	4.22					

PRESSURE DROP

Pressure Drop testing performed on 48" x 48" (1219 x 1219) unit.

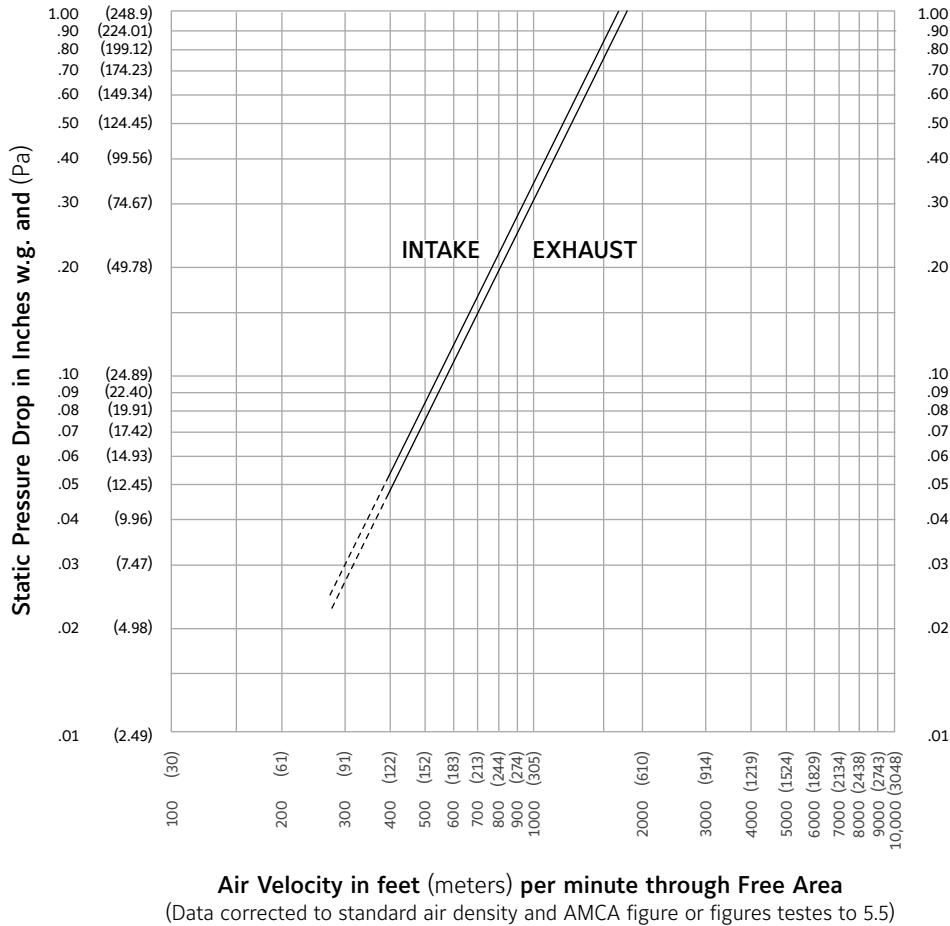

WATER PENETRATION GRAPH

Test size 48" wide X 48" high (1219 X 1219)

Beginning point of water penetration at .01 oz. /sq. ft. is above 1105 fpm (337 m/min).

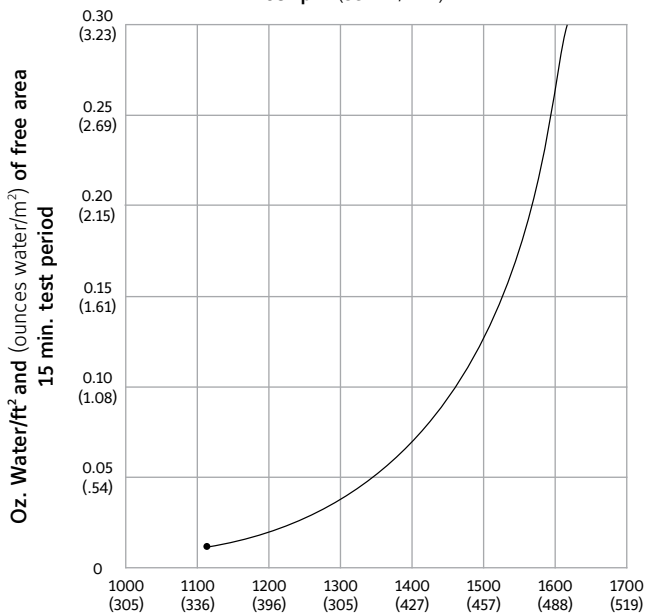

Ruskin Company certifies that the EME720 louver shown herein is licensed to bear the AMCA Seal. The ratings shown are based on tests and procedures performed in accordance with AMCA Publication 511 and comply with the requirements of the AMCA Certified Ratings Program. The AMCA Certified Ratings Seal applies to air performance ratings and wind driven rain ratings only.

WIND-DRIVEN RAIN PERFORMANCE

Test size is 1m x 1m (39 3/8" x 39 3/8") core area, 1.05m x 1.08m (41 1/2" x 43 1/4") nominal. Free Area of test louver is 6.85 ft² (.64m²).

Wind Velocity mph (kph)	Rain fall Rate In./hr. (mm/hr.)	Core Velocity ₁ fpm (m/s)	Airflow cfm (m ³ /min)	Free Area Velocity ₂ fpm (m/sec.)	Effectiveness Ratio	Class _{3, 4}	Discharge Loss Class ₃ Intake
29 (46.4)	3 (76)	497 (2.5)	5351 (152)	781 (4.0)	99.2%	A	3

NOTE:

1. Core area is the open area of the louver face (face area less louver frames).

Core Velocity is the airflow velocity through the Core Area of the louver (1m x 1m).
5 m/s is the maximum core velocity utilized in this test.

2. Free Area of test size is calculated per AMCA standard 500-L.

3. Wind Driven Rain Penetration Classes:

Class	Effectiveness
A	1 to .99
B	0.989 to 0.95
C	0.949 to 0.80
D	Below 0.8

4. The EME720 provides class A performance at all velocities up to and including 2.5 m/s core velocity.

5. Discharge Loss Coefficient is calculated by dividing a louvers' actual airflow rate vs. a theoretical airflow for the opening. It provides an indication of the louvers' airflow characteristics.

Class Discharge Loss Coefficient

1	0.4 and above
2	0.3 to 0.399
3	0.2 to 0.299
4	0.199 and below

(The higher the coefficient, the less resistance to airflow.)

6. The AMCA Wind Driven Rain Test is performed in a laboratory environment and incorporates controlled wind, water and system airflow effects. In actual field installations, storms may create conditions not considered by the AMCA test. Penthouse and similar applications where wind can pass through multiple louvers in an enclosure is another condition that is not simulated by AMCA tests. These applications can create elevated water penetration rates through any louver. Because of these uncontrolled situations it is recommended that provisions to manage water penetration through louvers be included in the building design.

TYPICAL INSTALLATION DETAILS

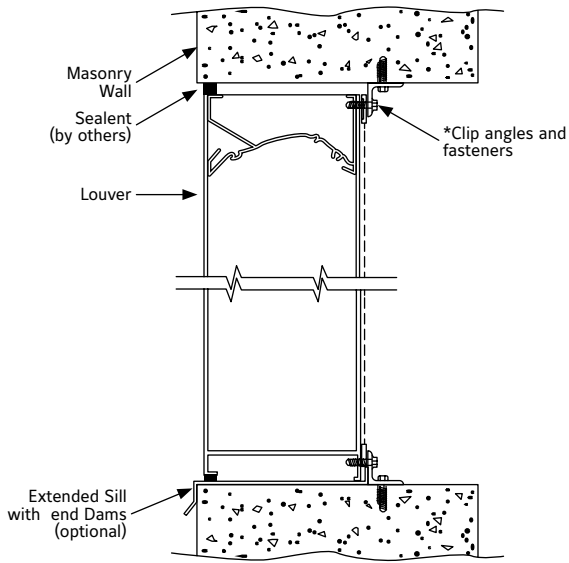

MASONRY WALL

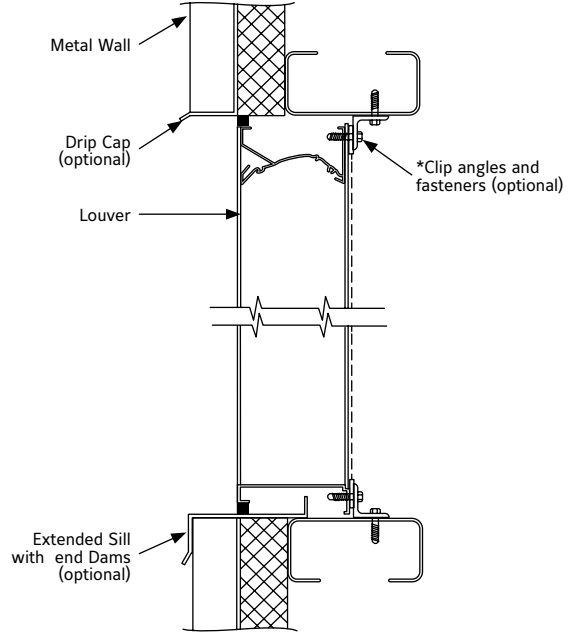

METAL PANEL WALL

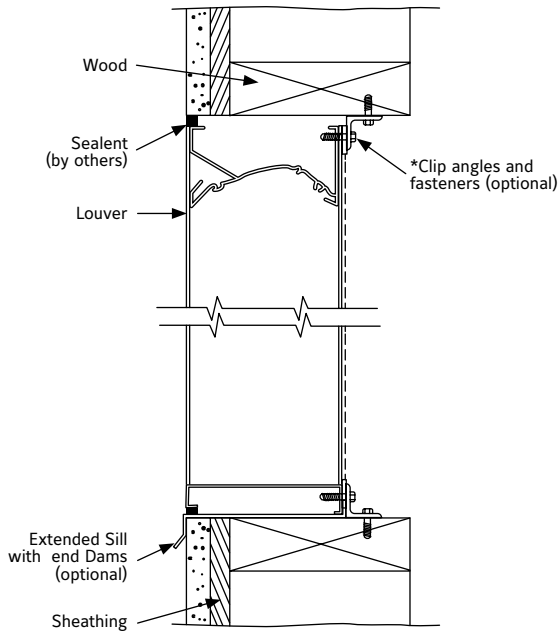

WOOD INSTALLATION

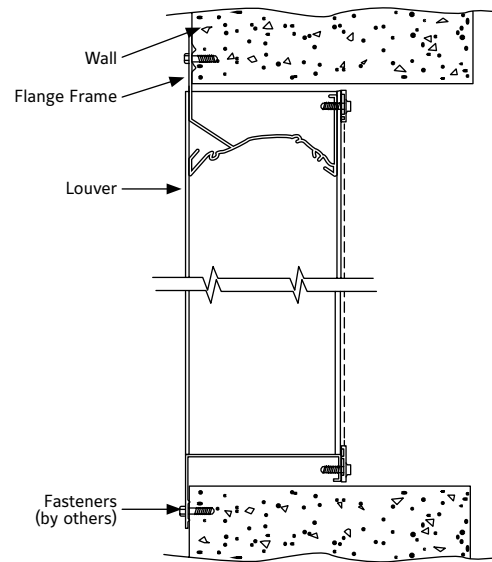

FLANGE MOUNT

Options available at additional cost. Fasteners to wall are by others.

SUGGESTED SPECIFICATION

Furnish and install louvers as hereinafter specified where shown on plans or as described in schedules. Louvers shall be stationary drainable type with drain gutters in each blade and downspouts in jambs and mullions. Louvers shall have a minimum of 55% free area based on a 48" wide x 48" high (1219 x 1219) size. Stationary drainable blades shall be contained within a 7" (178) frame. Louver components (heads, jambs, sills, blades, & mullions) shall be factory assembled by the louver manufacturer. Louver sizes too large for shipping shall be built up by the contractor from factory assembled louver sections to provide overall sizes required. Louver design shall limit span between visible mullions to 10 feet (3) and shall incorporate structural supports required to withstand a windload of 30 lbs. per sq. ft. (1.44KPa) (equivalent of a 110 mph wind [177 KPH] wind-specifier may substitute any loading required).

Louvers shall be Ruskin model EME720 extruded 6063T6 aluminum construction as follows:

Frame: 7" (178) deep, .080" (2.0) wall thickness.

Blades: .75" (1.9) nominal wall thickness.

Screen: 5/8" x .040" (16 x 1) expanded, flattened aluminum bird screen in removable frame. Screen adds approximately 1/2" (13) to louver depth.

Finish: Select finish specification from Ruskin Finishes Brochure.

LINKS TO IMPORTANT DOCUMENTS

Document Title
Paint Finishes and Color Guide
Limited Warranty Document



3900 Doctor Greaves Road
Grandview, MO 64030
Website: www.ruskin.com
Phone: (816) 761-7476